



EDIZIONI[®]
DESIGN

GENERAL CATALOGUE
2023



LAMPS

ed046

Ceiling lamp made by a circular tube and a frosted light tube.

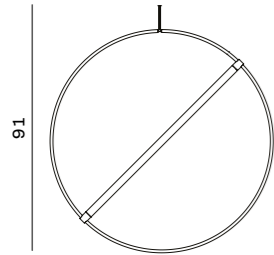

Voltage: 110/240V
Custom LED provided with driver.

Standard ceiling rose included
(driver has to be hidden in the countertop).

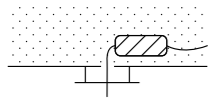

Optional ceiling rose with driver box.

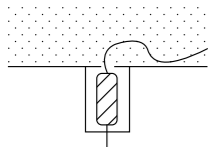

ed046.01
brass



ed046.03
chrome





ed058

Ceiling lamp with brushed brass structure, frosted light tube and glass rings.

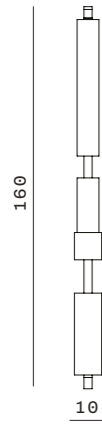

Voltage: 110/240V
Custom LED provided with driver.

Standard ceiling rose included
(driver has to be hidden in the countertop).

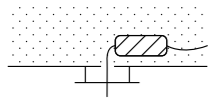

Optional ceiling rose with driver box.

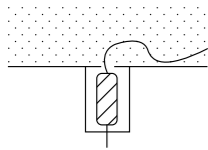

ed058.01
brass





ed045

Ceiling lamp with structure and frosted light tubes kept together by three elastic wires.

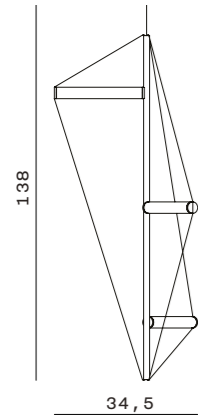

Voltage: 110/240V
Custom LED provided with driver.

Standard ceiling rose included
(driver has to be hidden in the countertop).

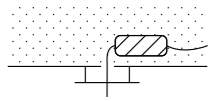

Optional ceiling rose with driver box.

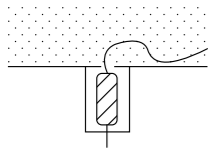

ed045.01
brass

ed045.03
chrome

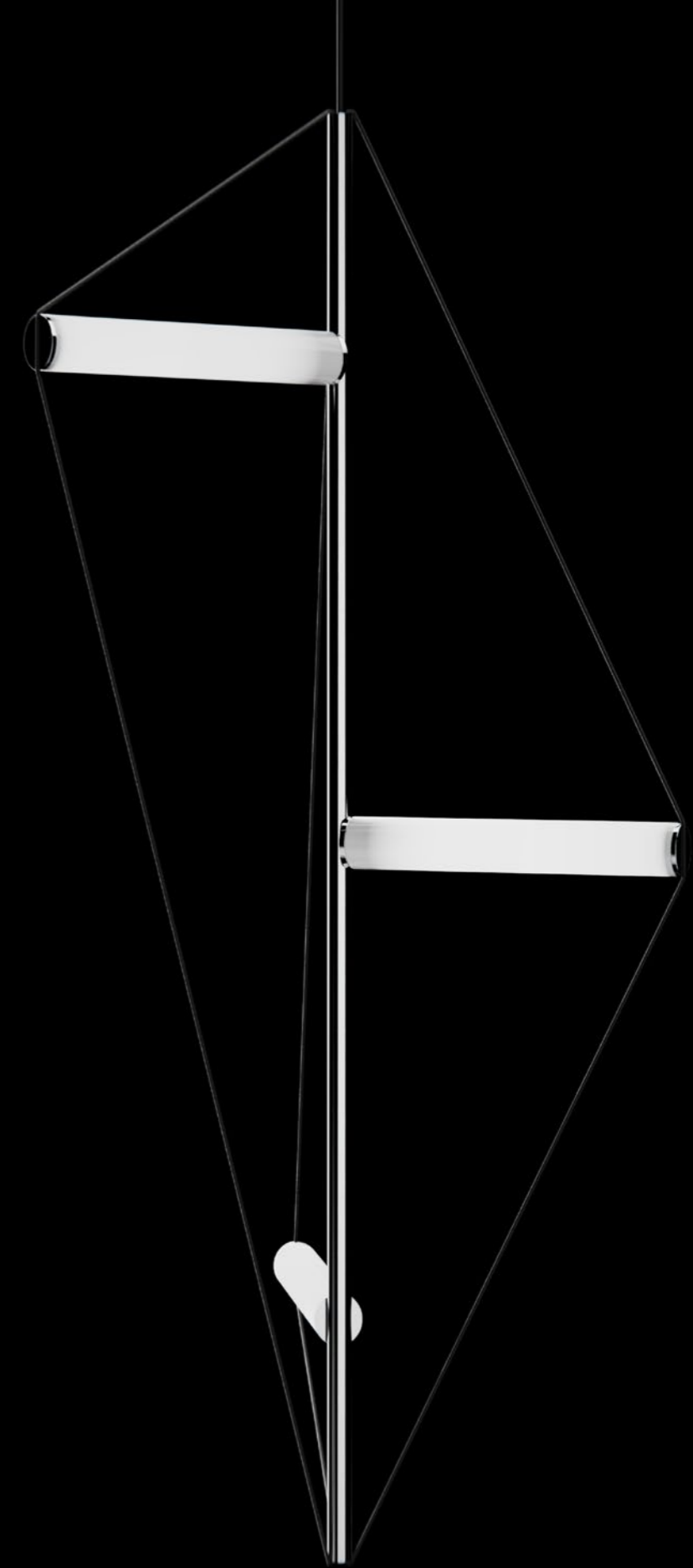



ed049

Reconfigurable table lamp; thanks to the elastic band, can be tilted at will.

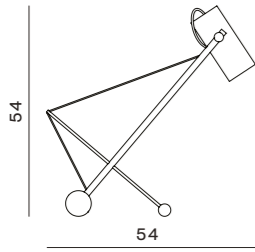

Socket: GU10 PAR16
Voltage: 110/240V



ed049.01
brass



ed049.02
black





ed057

Table lamp with frosted light sphere.

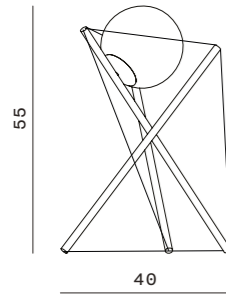

Socket: E27
Voltage: 110/240V



ed057.01
brass



ed057.02
black



ed057.03
chrome

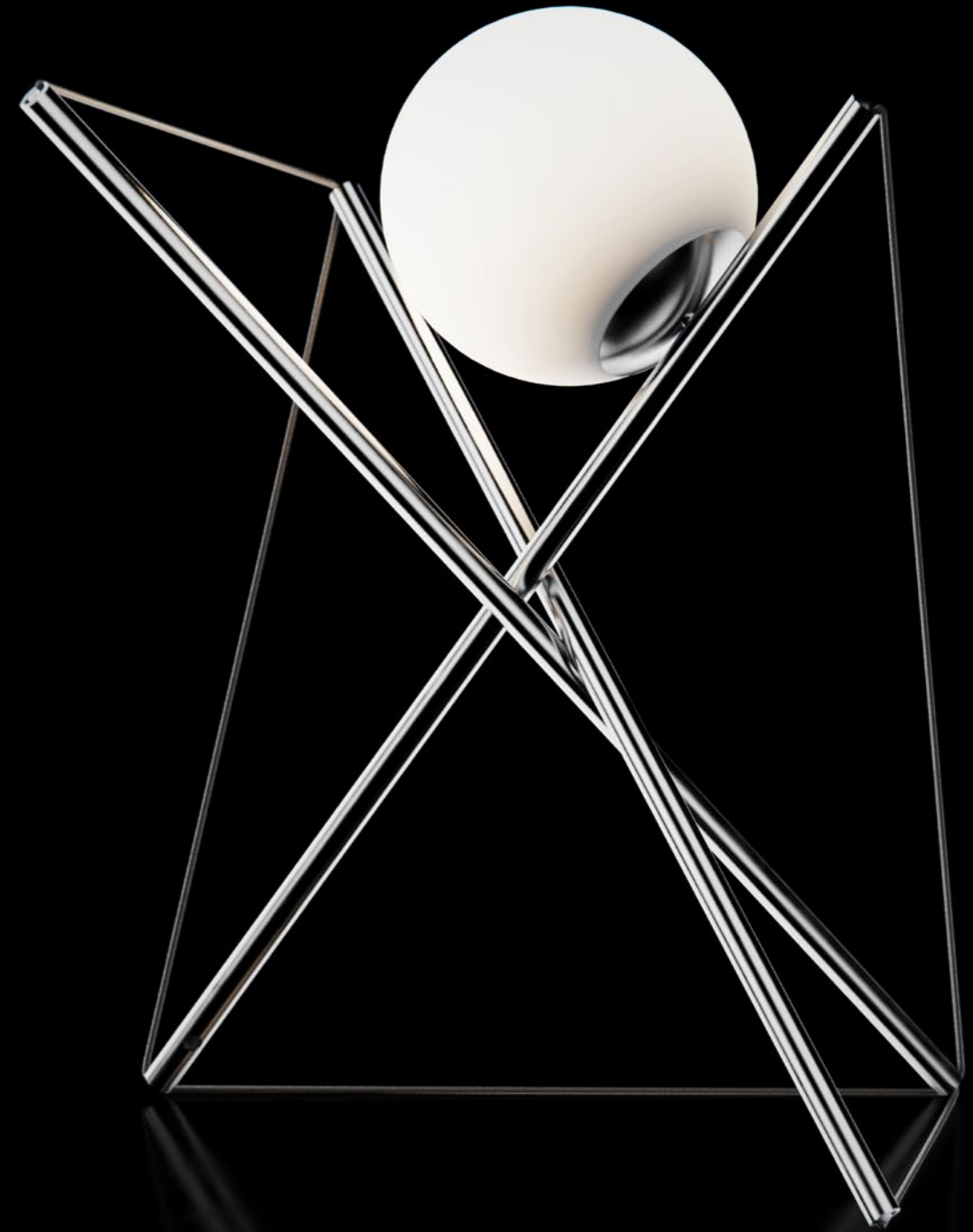



ed054

Ceiling lamp with brushed brass structure and frosted light tube.

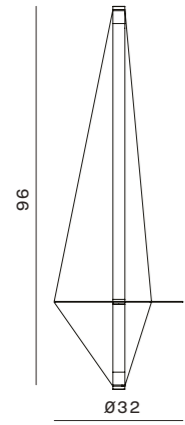

Voltage: 110/240V
Custom LED provided with driver.

Standard ceiling rose included
(driver has to be hidden in the countertop).

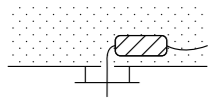

Optional ceiling rose with driver box.

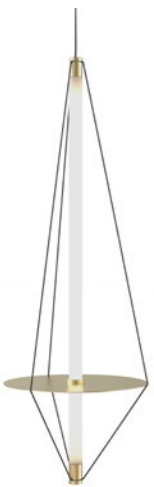
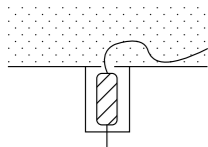

ed054.01
brass

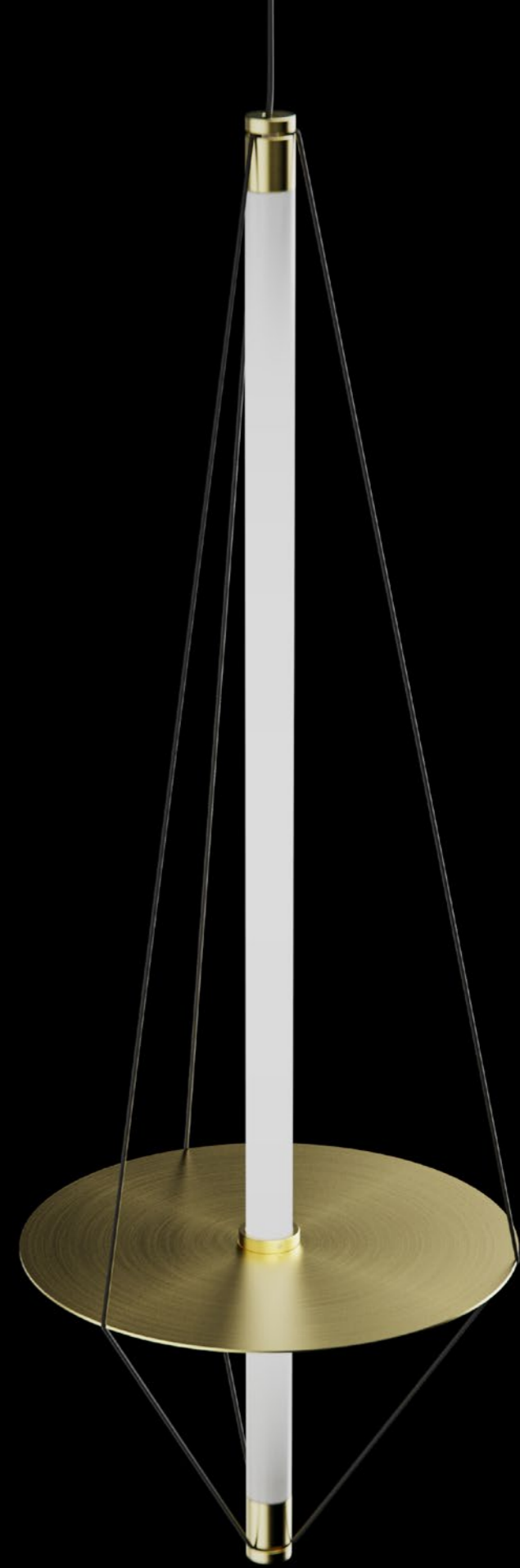

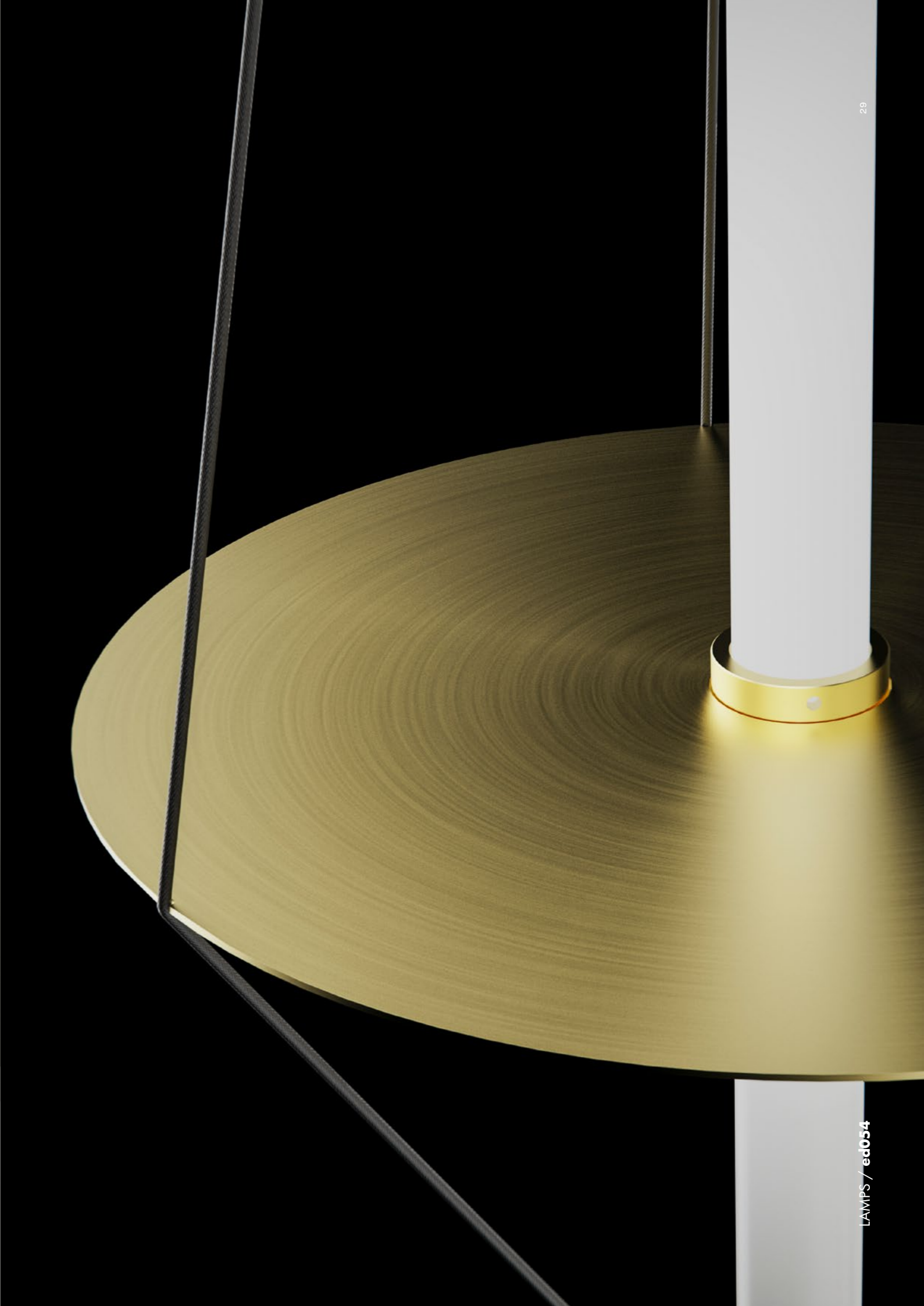

ed047

Floor lamp with stone base and frosted light tubes.

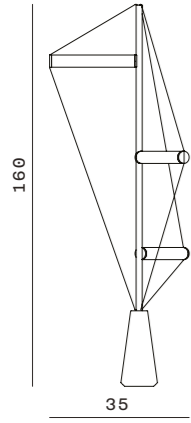

ed047.01
black stone
brass

ed047.02
black stone
chrome

ed047.03
white stone
chrome

ed047.04
white stone
brass

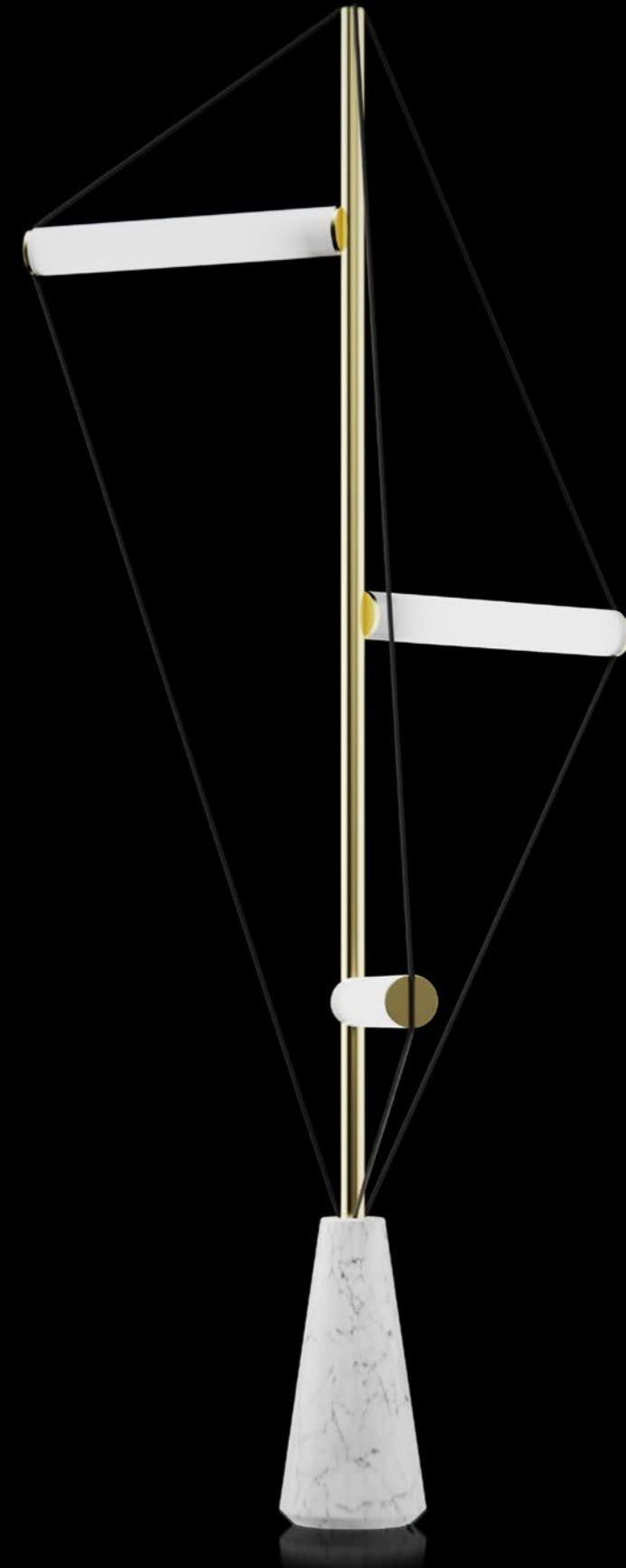

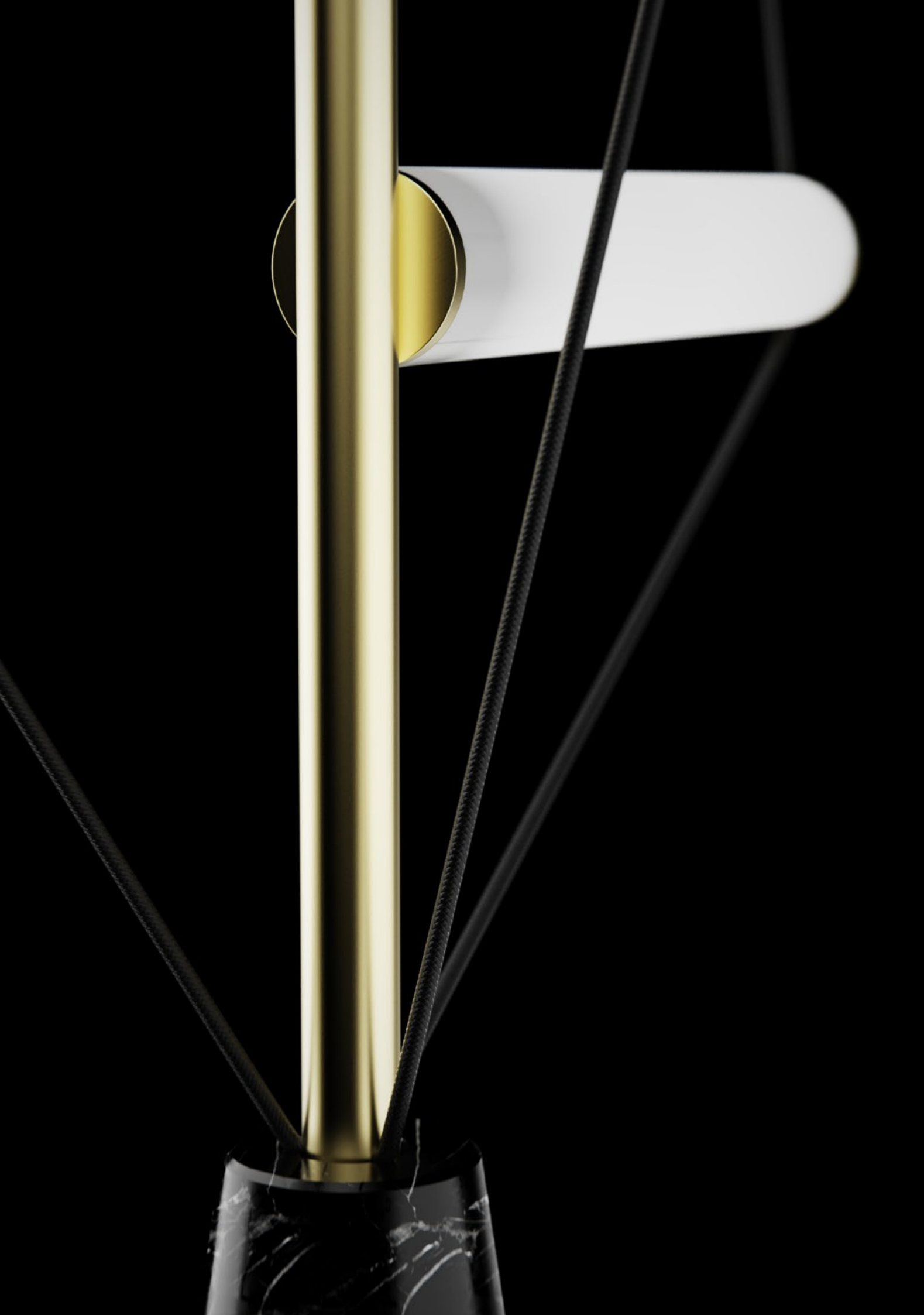

ed005

Reconfigurable table lamp; thanks to the two holes on the base, can be used as a table lamp or as an ambient light.

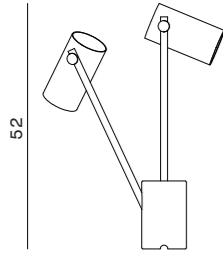

Socket: GU10 PAR16
Voltage: 110/240V



ed005.01

black



ed005.05

brass





ed027

Floor lamp with stone base and double lightshield.

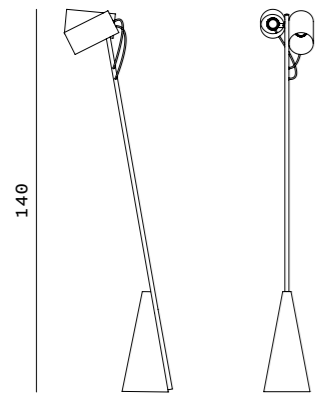

Socket: GU10 PAR16
Voltage: 110/240V



ed027.01
black stone
black
brass

ed027.02
black stone
black
black

ed027.03
grey stone
black
black

ed027.04
black stone
chrome
black



ed027.05
carrara stone
chrome
black

ed027.06
grey stone
black
brass

ed027.07
carrara stone
black
brass

ed027.08
carrara stone
black
black

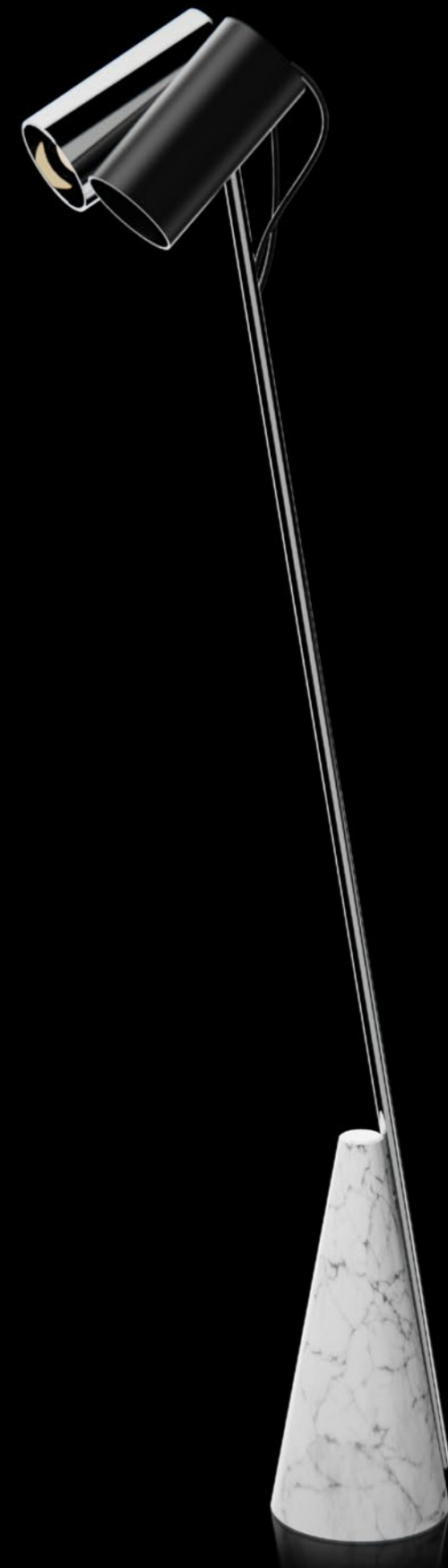



ed059

Reconfigurable floor lamp; thanks to the elastic band, can be tilted at will.

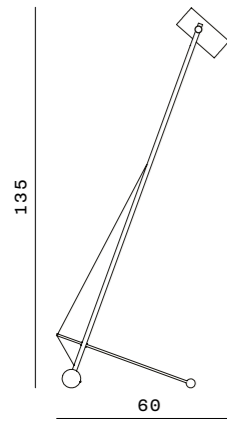

Socket: GU10 PAR16
Voltage: 110/240V



ed059.01
brass

ed059.02
black

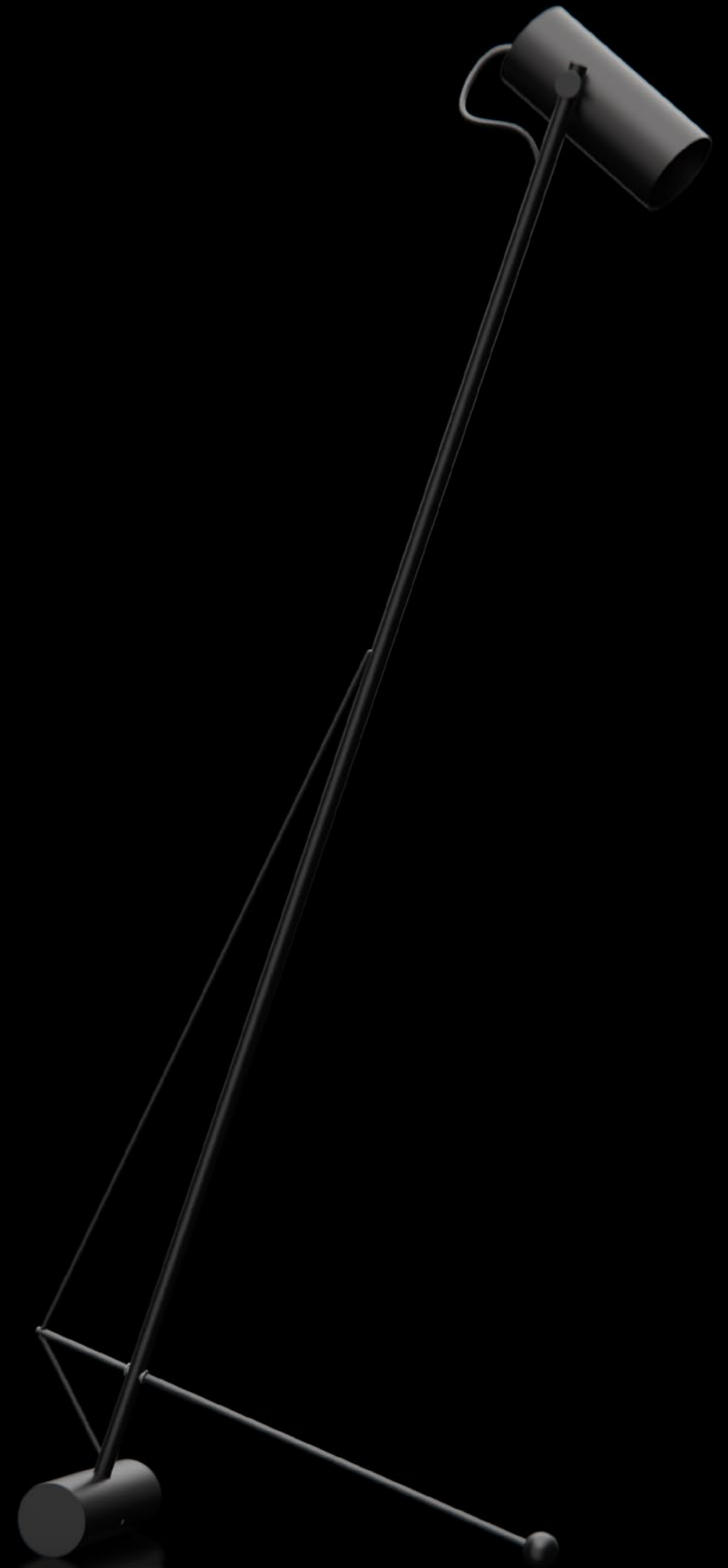



ed029

Table lamp with lightshade and solid brushed brass base.

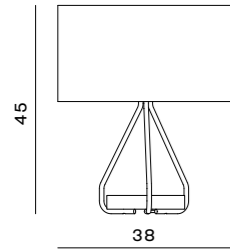

Socket: G9
Voltage: 110/240V



ed029.01

brass
black





ed030

Table lamp with brushed brass, wood and black paint structure.

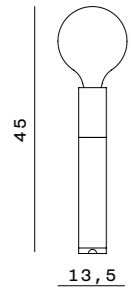

Socket: E27
Voltage: 110/240V
Light bulb provided



ed030.01

black wood
brass
black



ed030.02

natural wood
brass
black



ed030.03

black wood
black
black



ed030.05

natural wood
black
black





ed037

Ceiling lamp with wood structure and lampshade.

The wooden triangular structure can be freely tilted allowing the lamp's shape to generate multiple geometrical forms.

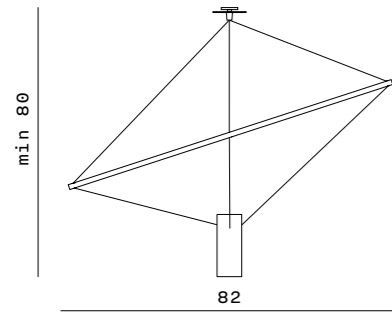

Socket: GU10 PAR16
Voltage: 110/240V



ed037.01

natural wood
brass



ed037.02

natural wood
black



ed037.03

black wood
brass



ed037.04

black wood
black

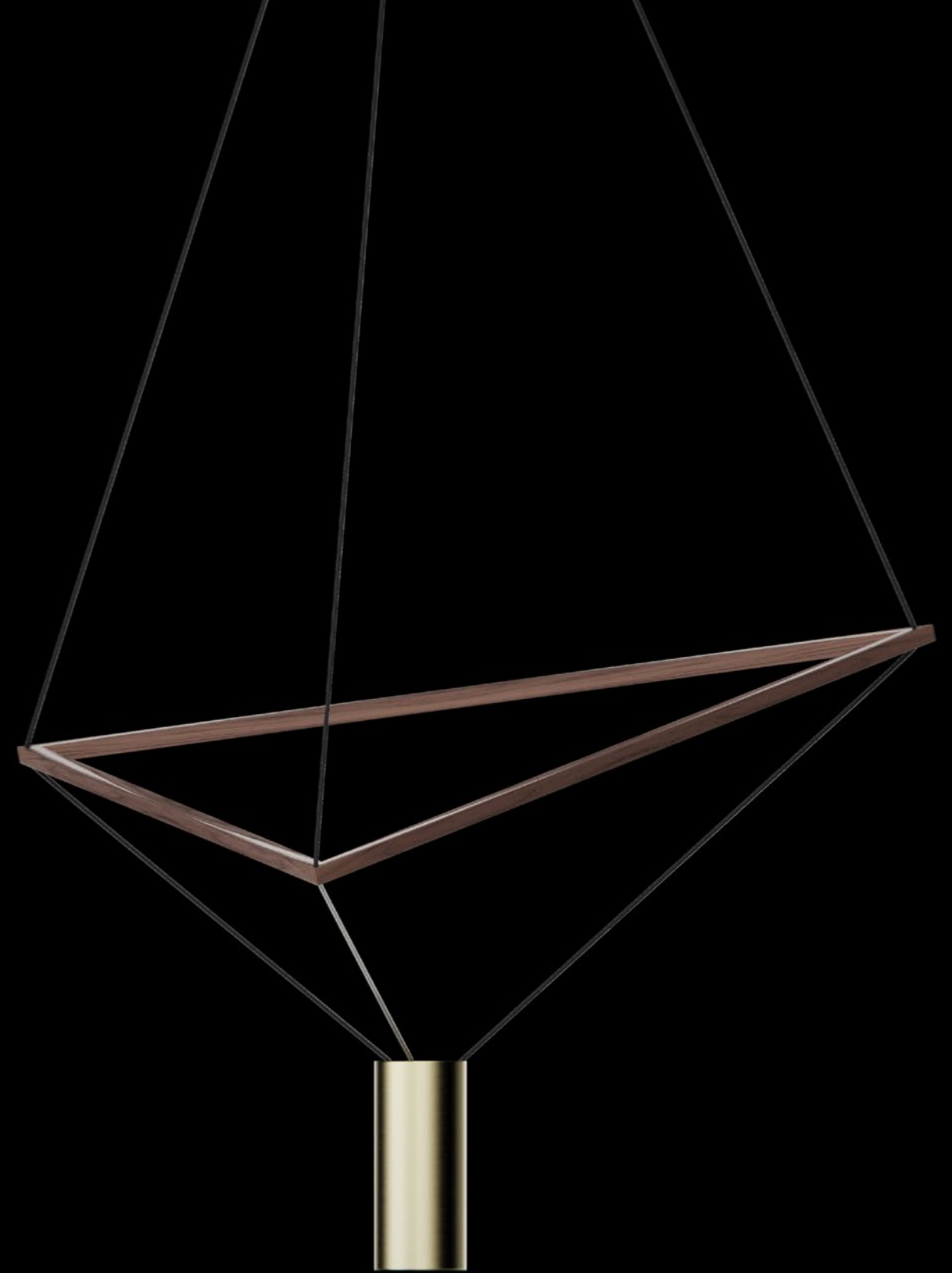

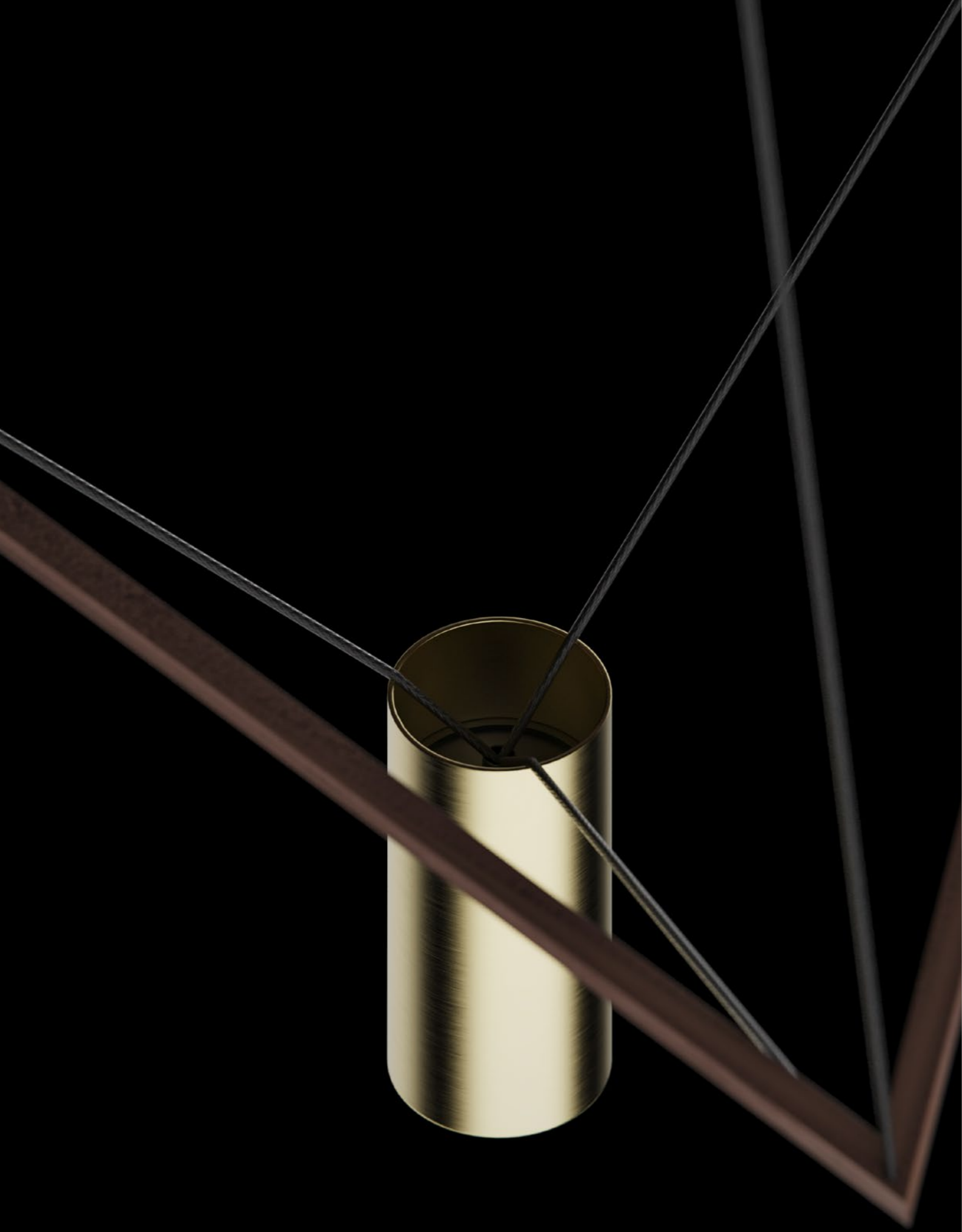

ed038

Table lamp with stone base and conic lightshade.

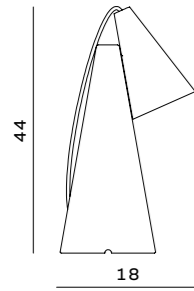

Socket: GU10 PAR16
Voltage: 110/240V



ed038.01

green stone
brass



ed038.02

grey stone
bronze



ed038.03

black stone
bronze



ed038.04

black stone
brass



ed038.05

grey stone
black



ed038.06

grey stone
brass



ed038.07

black stone
black



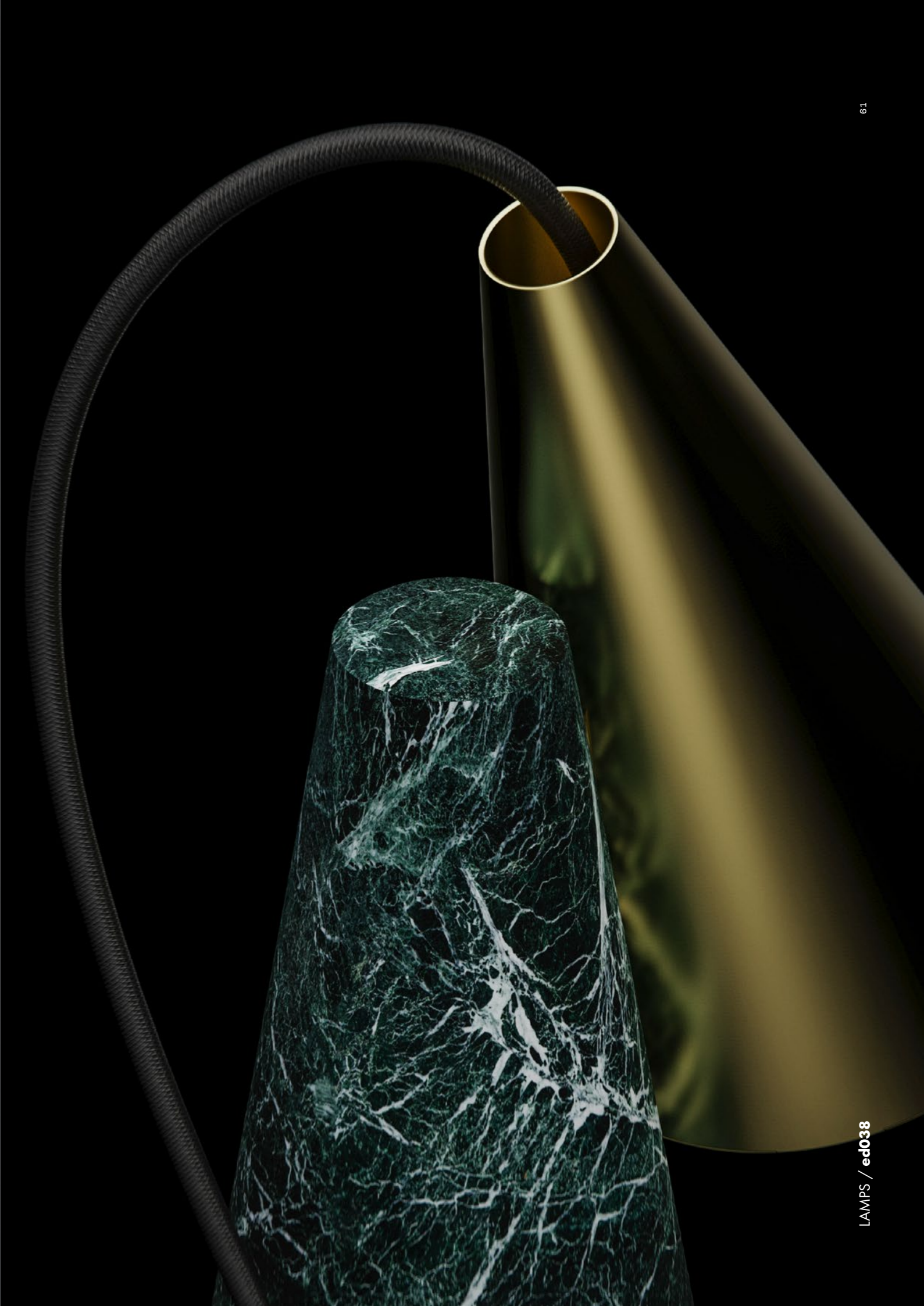

ed039

Table lamp with stone base and lightshade.

The light shade is disconnected from the stone base and free to tilt, allowing multiple change of styles.

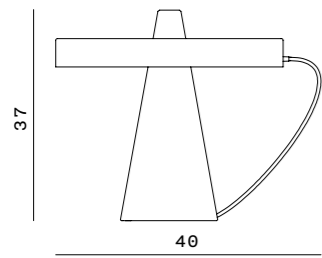

Socket: RING LIGHT
Voltage: 110/240V



ed039.01
black stone
black



ed039.02
green stone
brass



ed039.03
grey stone
bronze



ed039.04
black stone
bronze



ed039.05
black stone
brass



ed039.06
grey stone
black



ed039.07
grey stone
brass



ed039.08
white stone
brass



ed039.09
green stone
bronze







COMPLEMENTS

ed044

Valet stand with stone base.

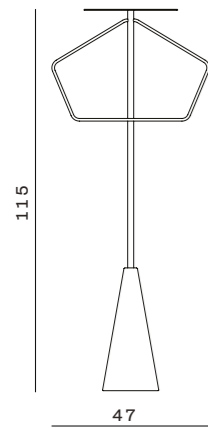

ed044.01

black stone
brass

ed044.02

red stone
brass

ed044.03

red stone
brass

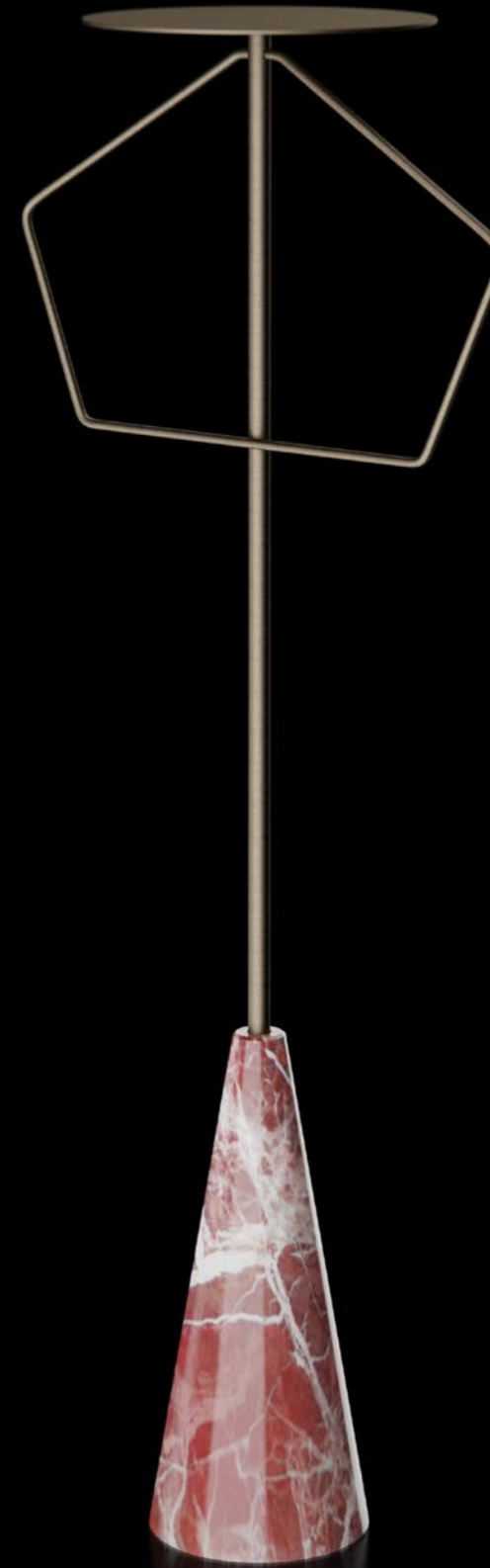



ed004

Reconfigurable side table with stone base.

The table's height can be set in three different levels.

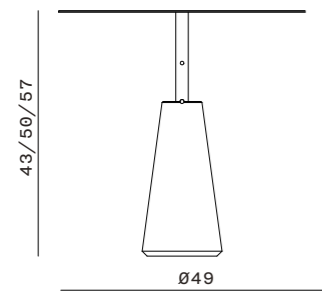

ed004.01

grey stone
steel



ed004.02

red stone
bronze



ed004.03

grey stone
bronze





ed021

Side table made in lasercut metalsheet with an interlock structure.

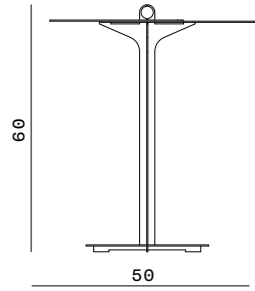

ed021.01

brass
brass



ed021.02

black
black



ed021.03

brass
black



ed021.07

black
brass





The image features a series of concentric, curved lines that create a sense of depth and movement. The lines are primarily in shades of gold and dark grey, set against a solid black background. The curves are most prominent on the right side of the frame, where they appear to be part of a larger, circular or semi-circular structure. The lighting is dramatic, highlighting the metallic texture of the gold lines and the smooth, dark surface of the grey lines. The overall composition is minimalist and modern, with a strong emphasis on geometric forms and color contrast.

MIRRORS

ed031

Wall mirror made of black wood, brushed brass and black paint structure.

The mirror is provided with four hanging points, allowing the mirror itself to be mounted in four different positions.

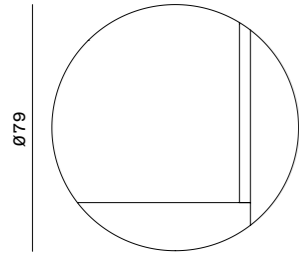

ed031

black
brass





ed032

Modular wall mirror with black paint structure and rails with different finishes.

The rails can be adjusted to give to the mirror multiple forms.

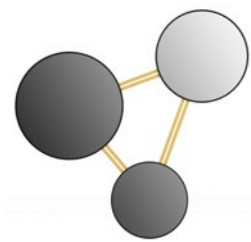
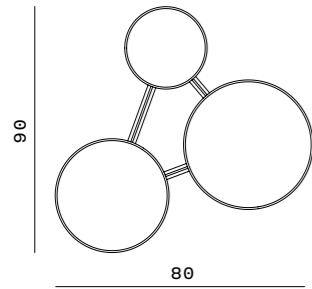

ed032.01

black
brass

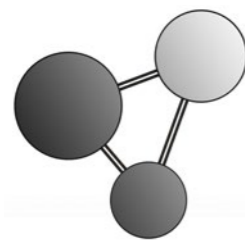

ed032.02

black
black

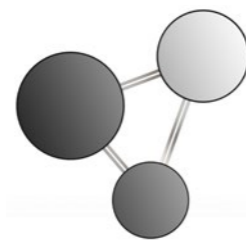

ed032.03

black
chrome

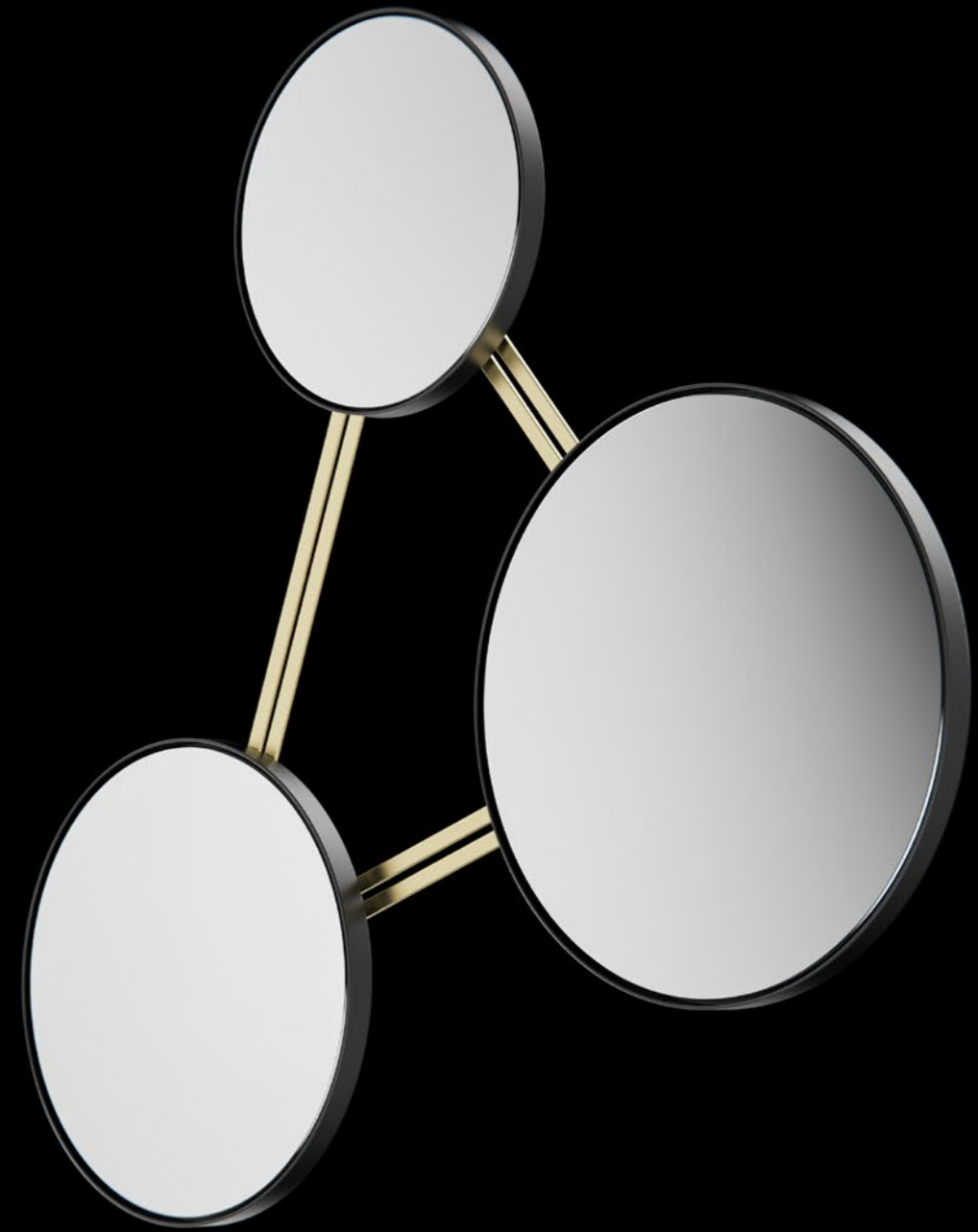

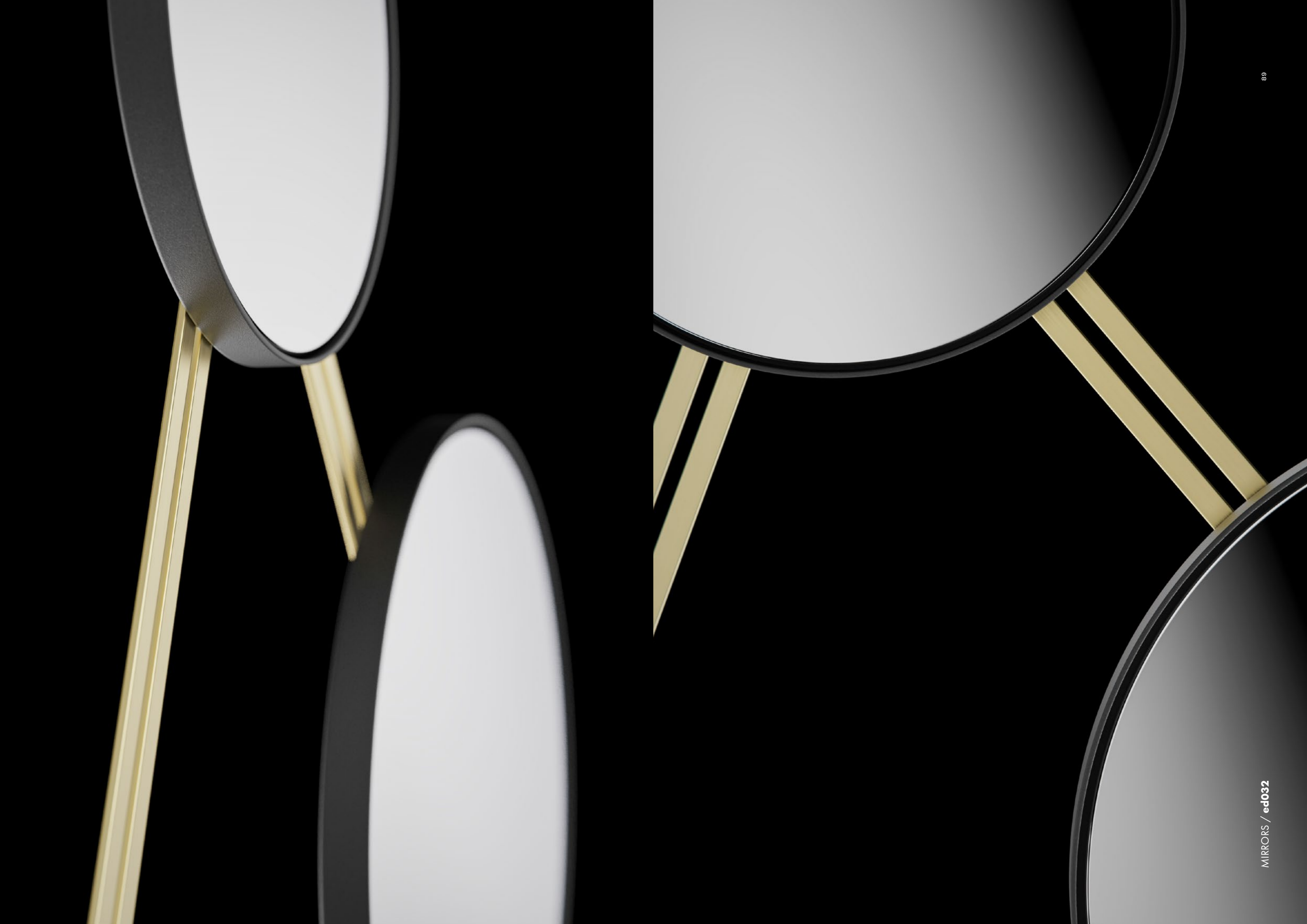

ed034

Wall mirror with black paint and brushed brass structure.

The mirror is provided with four hanging points, allowing the mirror itself to be mounted in four different positions.

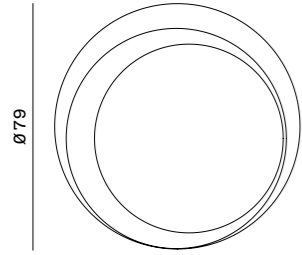

ed034

black
brass

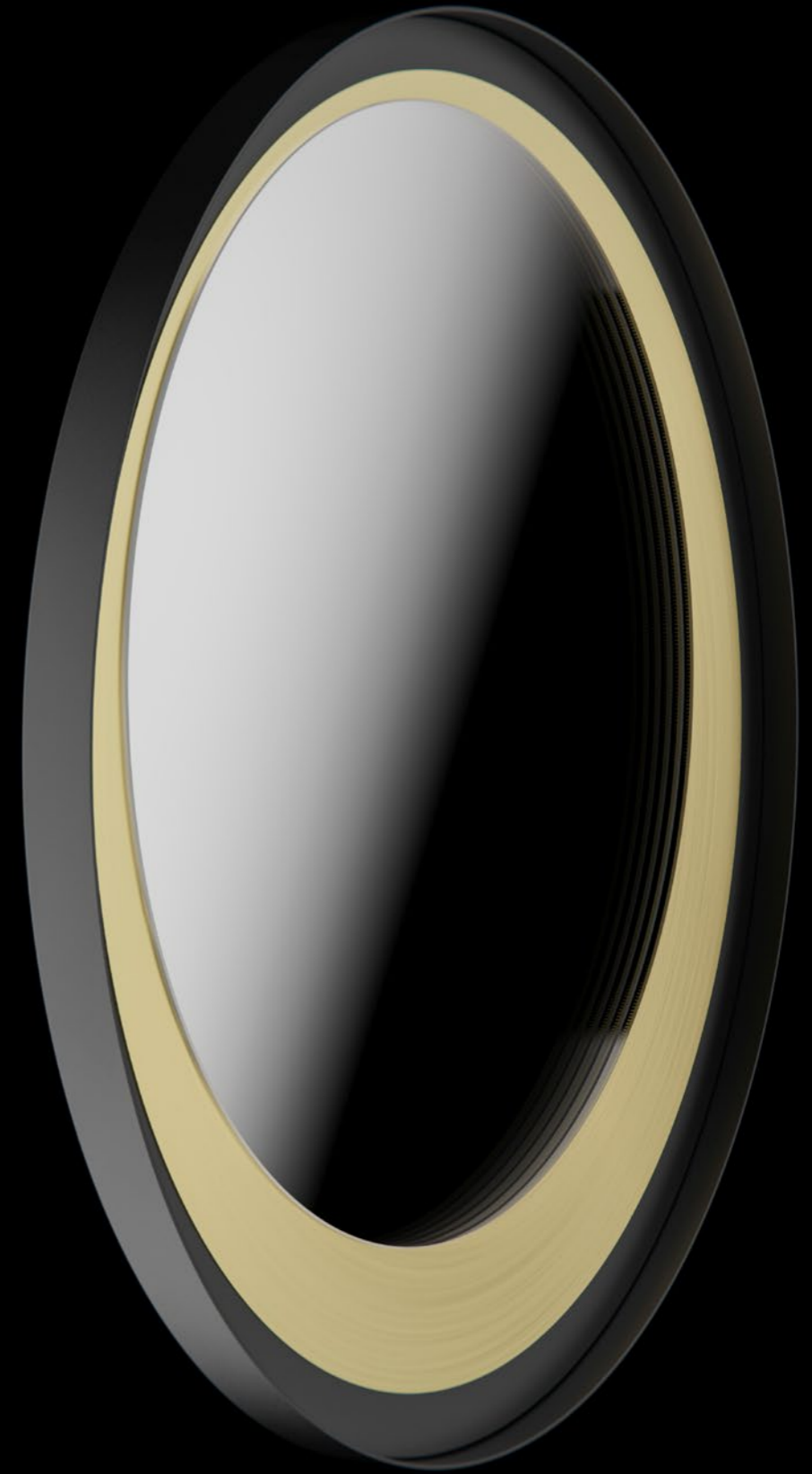

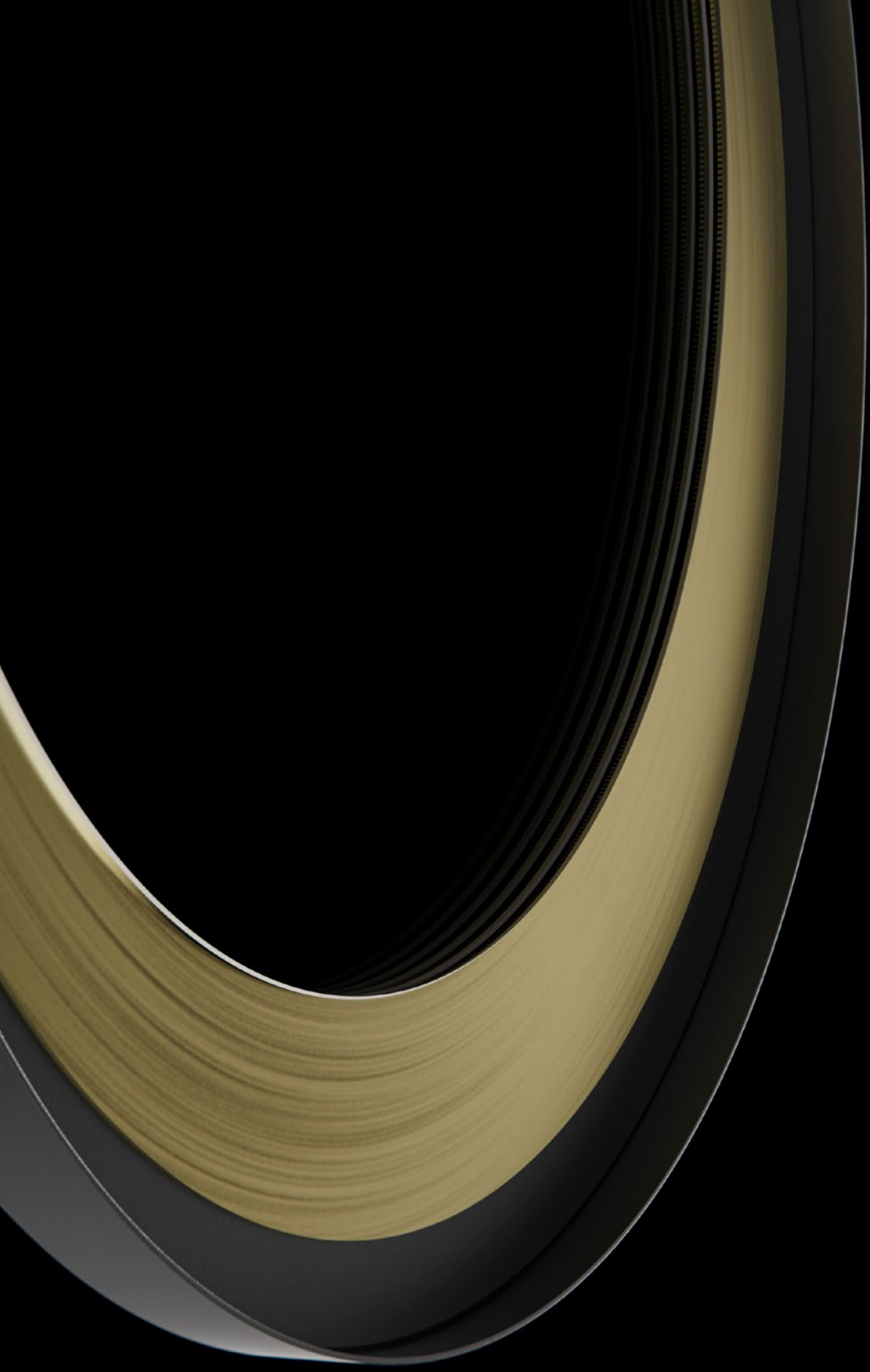

ed014

Bended clothhanger with solid base.

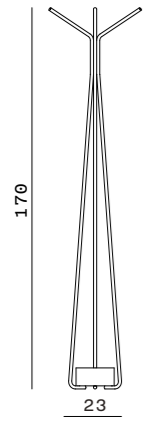

ed014.01
brass



ed014.02
steel



ed014.03
black



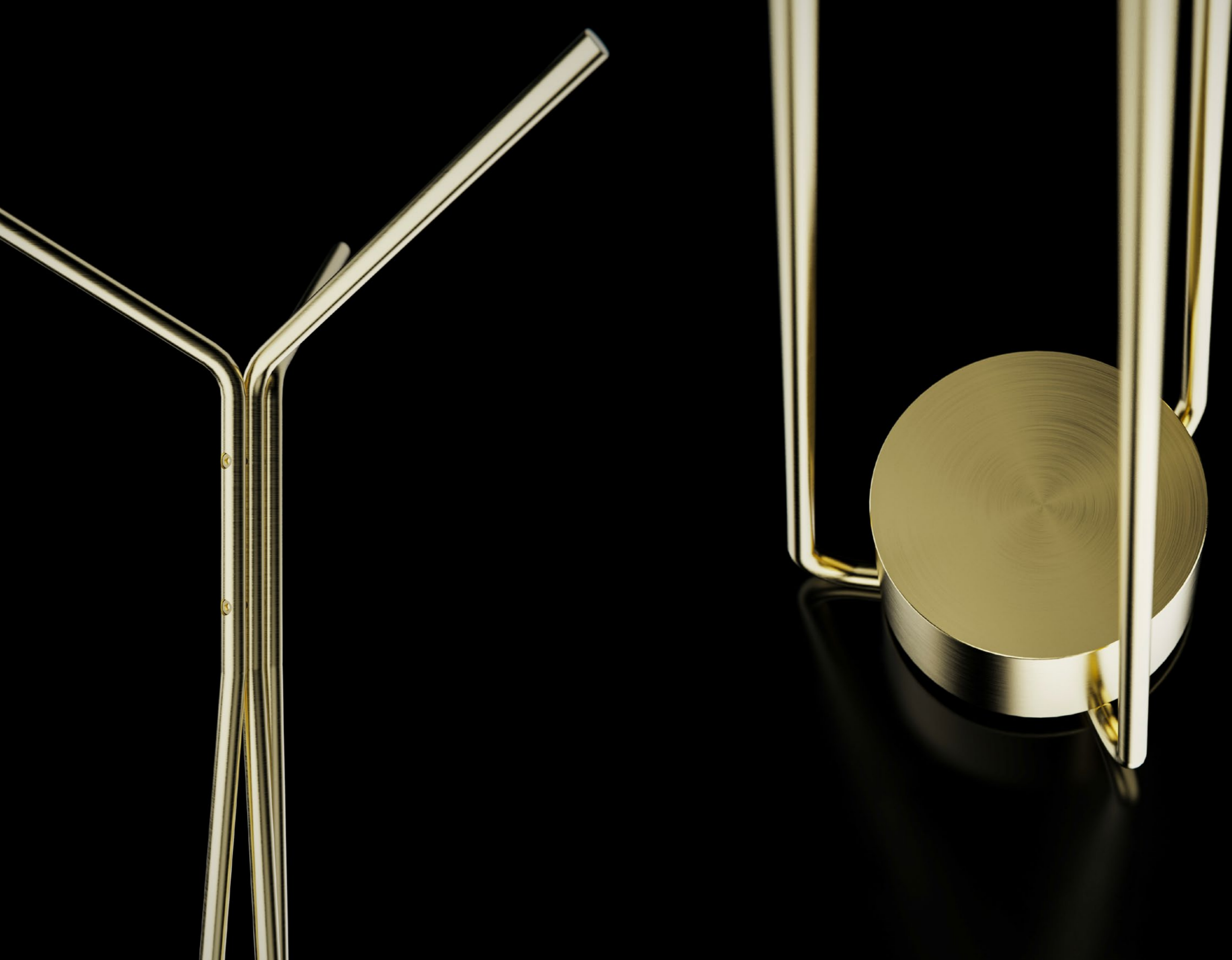

FIREPLACE



ed001

Fireplace tools set with brushed brass handles.

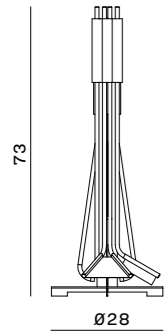

ed001.01

steel
brass



ed001.02

black
brass

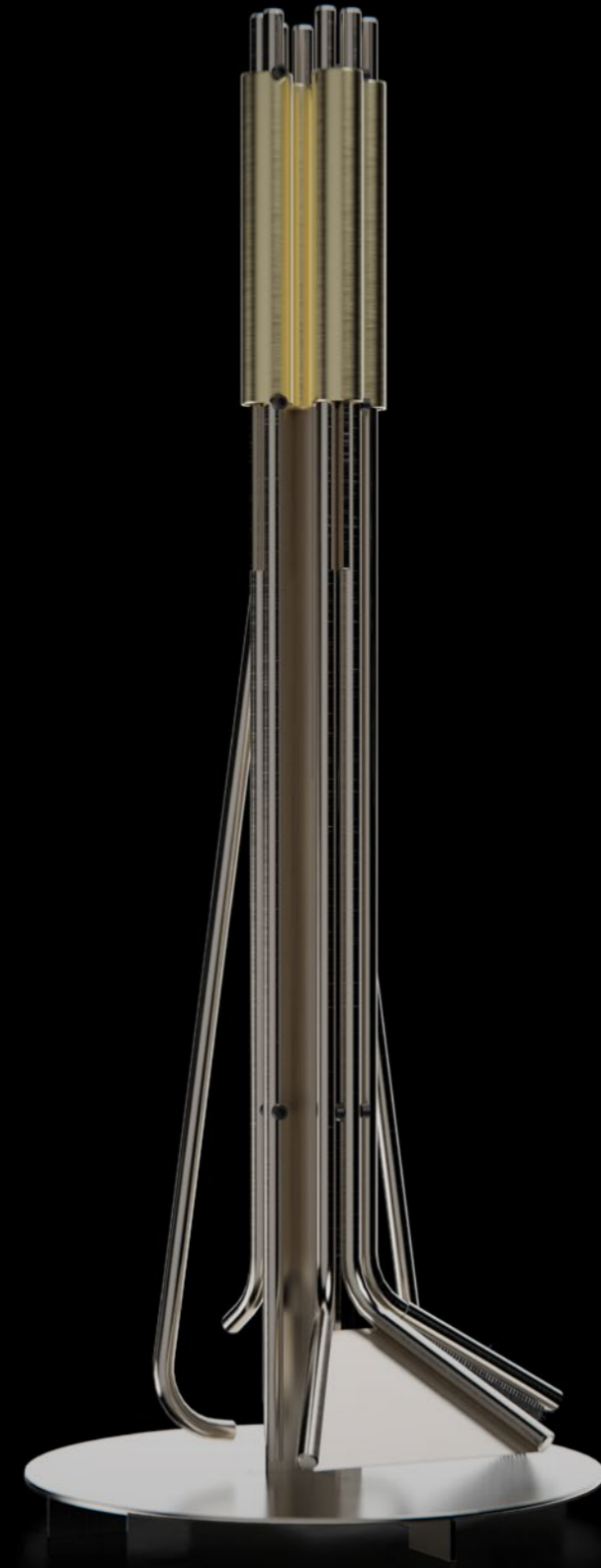



ed009

Fireplace shield made of folded and lasercut metalsheet;
feet made in carved brushed brass.

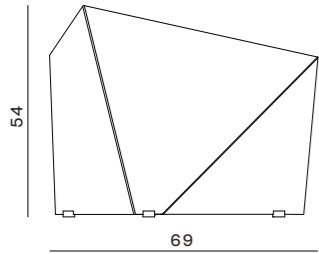

ed009.01

steel
brass



ed009.02

black
brass



ed009.03

brass
brass

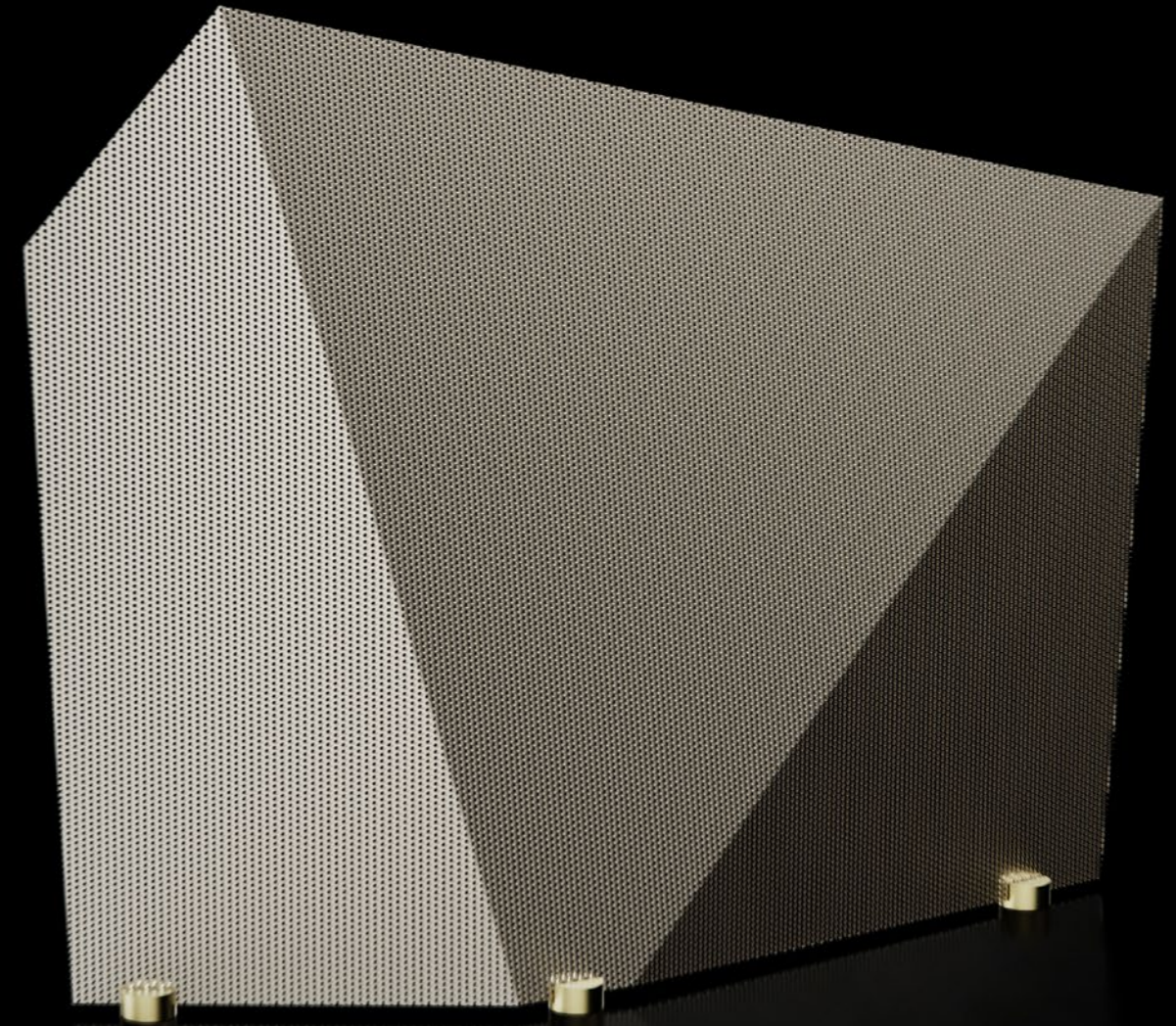



ed010

Solid steel andirons with oil finish and solid brushed brass joints.

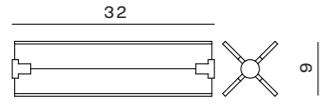

ed010

steel
brass

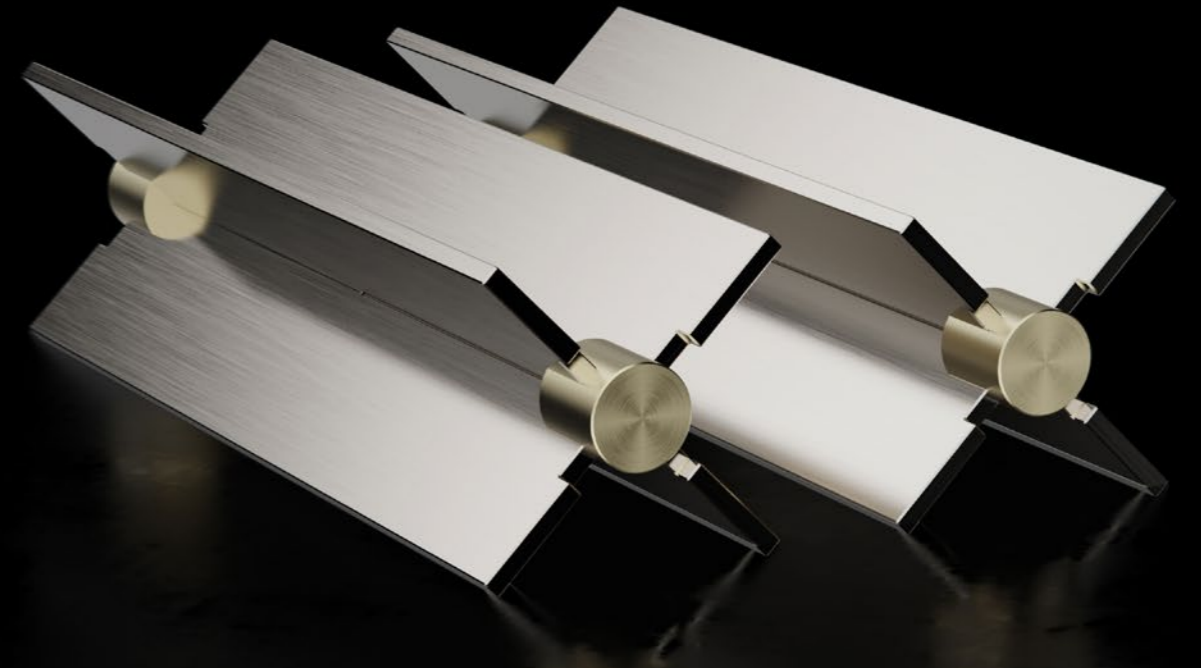

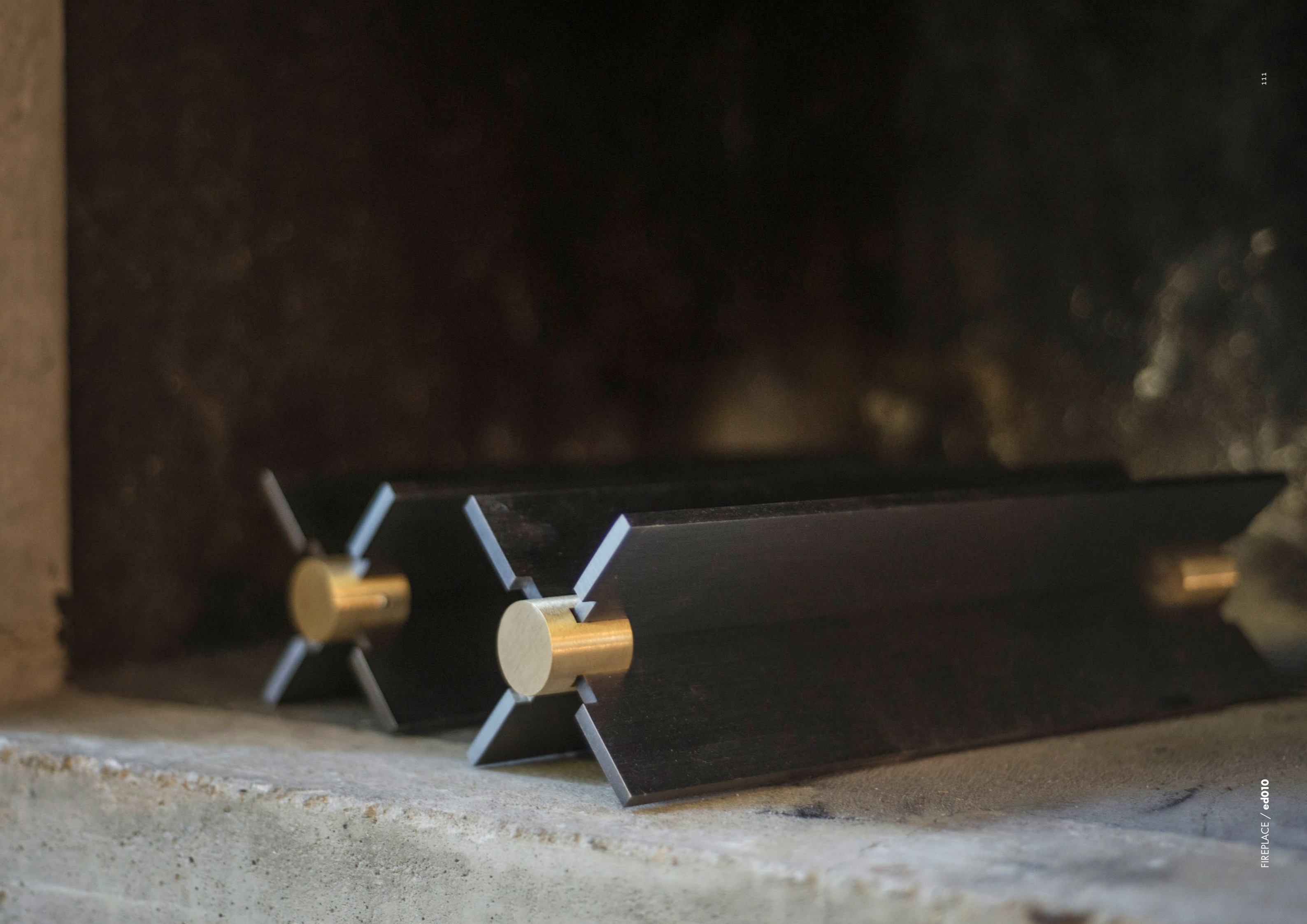



EDIZIONI[®]

DESIGN

//

EDIZIONI DESIGN
Via Arena, 19
20123 Milano - Italia
T +39 02 49474956
welcome@edizionidesign.com
edizionidesign.com

//

ART DIRECTION / PHOTOGRAPHY / CGI
ASPS Design Studio
as-ps.it

//

edizionidesign.com

//

all rights reserved 2013 — 2023